

Article number: 25075664002

Description: ICME Single-phase motor MD90 L6 0,75KW
6 - 900 rpm 1x230 Volt 50Hz B5 with starting & running capacitor

Measures

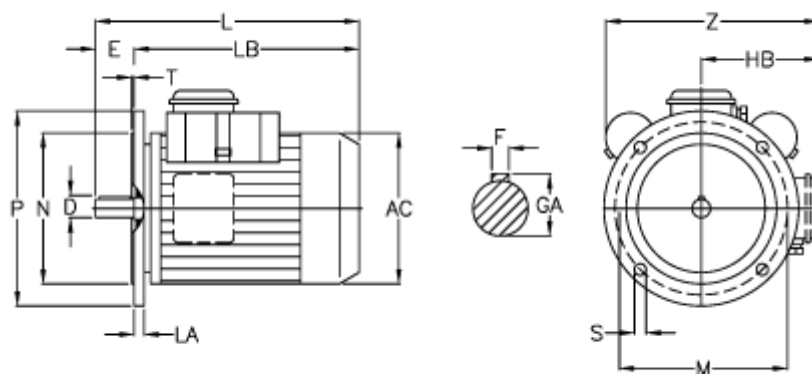

AC = 176	LB = 316
D = 24	M = 165
E = 50	N = 130
F = 8	P = 200
GA = 27.0	S = 11.5
HB = 129	T = 3.5
L = 366	Z = 246
LA = 12.0	